

# MCB 202 SINGLE MIX CENTRAL DISTRIBUTION BICARB SYSTEM

## OPERATION & MAINTENANCE MANUAL

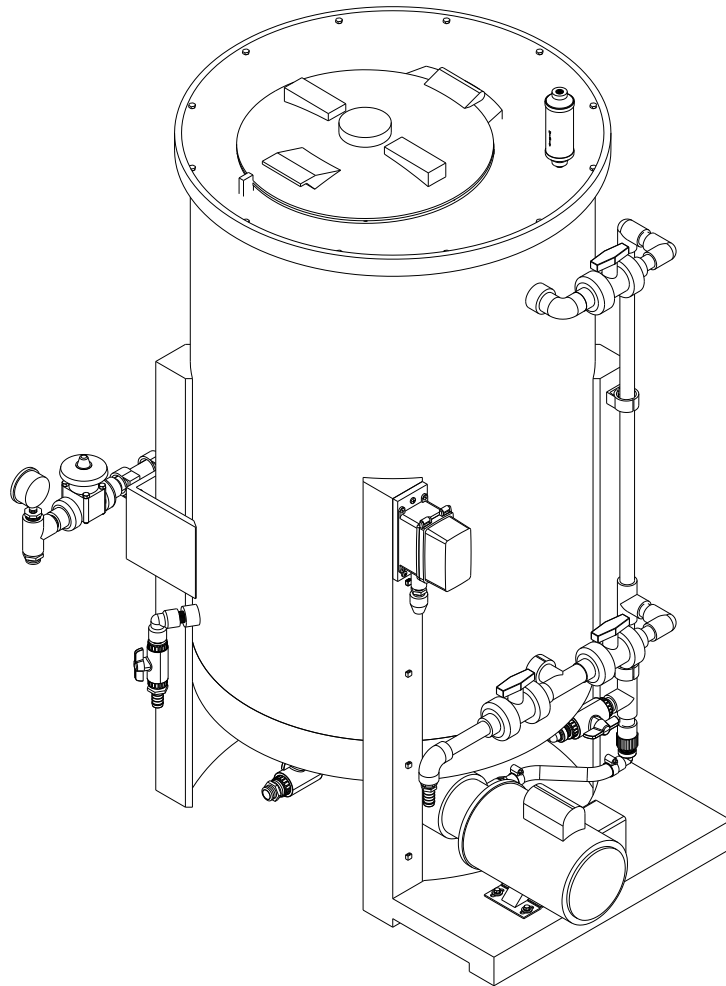



**MCB 202 Single Mix Central Distribution Bicarb  
Installation, Operation, and Maintenance Manual**

---

**TABLE OF CONTENTS**

<b>CHAPTER ONE:</b>		<b>GENERAL INFORMATION</b>	<b>1</b>
Section	1.1	General	1
	1.2	Safety	1
<b>CHAPTER TWO:</b>		<b>SYSTEM INFORMATION</b>	<b>3</b>
Section	2.1	Utility Requirements	3
	2.2	Dimensions/Operating Space	4
	2.3	Installation	4
	2.4	Components of the Bicarb System	5
	2.5	Service Assistance	7
	2.6	Symbols and Abbreviations	7
	2.7	Environmental and Storage Consideration	7
<b>CHAPTER THREE:</b>		<b>INITIAL SYSTEM START-UP</b>	<b>8</b>
Section	3.1	Bicarb System Set-Up	8
<b>CHAPTER FOUR:</b>		<b>SYSTEM OPERATION</b>	<b>9</b>
Section	4.1	Bicarb Mixing	9
	4.2	Bicarb Distribution	10
<b>CHAPTER FIVE:</b>		<b>SYSTEM CLEANING AND DISINFECTING</b>	<b>11</b>
Section	5.1	Introduction	11
	5.2	Bicarb System Pre-Rinse	11
	5.3	Bicarb System Disinfecting	12
	5.4	Bicarb System Rinse	13
<b>CHAPTER SIX:</b>		<b>SYSTEM MAINTENANCE</b>	<b>15</b>
Section	6.1	Bicarb Components	15
	6.2	Schedule	16
<b>CHAPTER SEVEN:</b>		<b>SYSTEM TROUBLESHOOTING</b>	<b>17</b>
Section	7.1	Mix/Distribution Pump	17
	7.2	Tank Fill	17
	7.3	System Flow	17
<b>CHAPTER EIGHT:</b>		<b>SPARE PARTS &amp; SUPPLIES</b>	<b>18</b>
<b>CHAPTER NINE:</b>		<b>DRAWINGS</b>	<b>19</b>

## CHAPTER ONE: GENERAL INFORMATION

### 1.1 General

This manual describes the installation and operation of a Mar Cor Purification MCB 202CD Single Tank Mix & Delivery Bicarb System. This Bicarb System designed and manufactured by Mar Cor Purification is safe, reliable and easy to use. This system will reduce staff time by providing consistent bicarb mixing, and thorough system cleaning and disinfection. This bicarb system is equipped with the optional central distribution hardware. This option includes diaphragm valves and loop connections for the purpose of delivering bicarb solution to intended points-of-use.



Standard features of the Bicarb System include:

- All Polyethylene tanks and control units for easy cleaning.
- 3/4 hp (100-gallon) or 1/2 hp (50-gallon) Totally Enclosed Fan Cooled (TEFC) motors.
- 50-Gallon or 100-Gallon Systems is available.
- Ports for connecting to bicarb distribution loop.

Model Number	Part Number	Description
MCB 202-50	200-02-251	Bicarb Mix, Central Distribution, 50 Gallon Tank
MCB 202-100	200-02-252	Bicarb Mix, Central Distribution, 100 Gallon Tank

### 1.2 Safety

Throughout this manual, the following safety words and symbols signify important safety issues with regard to installing and maintaining the system. This safety does not contain all of the safety statements in the manual. Other safety statements are included within the manual text by the following denotations and are highlighted in bold print.

	<b>NOTE:</b>	Statement that provides further clarification.
	<b>CAUTION:</b>	Statement used to identify conditions that could result in equipment or property damage. Failure to observe may result in damage to the system.
	<b>WARNING:</b>	Statement used to identify conditions that could result in personal injury or loss of life
	<b>PROTECTIVE CONDUCTOR TERMINAL:</b>	The symbol shows the Protective Conductor Terminal label used in the equipment.

**Read This Manual:**

This manual needs to be read and understood prior to operating or servicing this device. Use this manual for future reference or training.

**Electrical:**

- a. To avoid electrical shock, do not open control panel.
- b. Plug should be removed from wall outlet during servicing.
- c. Do not use an extension cord for operation.
- d. Use only with a grounded outlet and ensure that ground is in plug.

**Labeling:**

Do not remove any system labels. All labels are important and necessary for understanding system operation. The warning label listed below should be adhered to at all times.

**Transporting:**

When lifting or carry the MCB 202CD use at least 2 persons or properly rated lifting equipment. Ensure all proper safety equipment is used when moving this device.

**Use:**

Do not use the MCB 202CD in hazardous atmospheres or with hazardous material for which the equipment is not designed. If the MCB 202CD is used in a manner not specified by the manufacturer the protective features of the unit might be impaired.

**Electromagnetic Interference**

This equipment generates uses and can radiate frequency energy and, if not installed and used in accordance with these instructions, may cause harmful interference to other devices in the vicinity. However, there is no guarantee that interference will not occur in a particular installation. If this equipment does cause harmful interference with other devices, which can be determined by turning the equipment off and on, the user is encouraged to try to correct the interference by one or more of the following measures:

- Reorient or relocate the receiving device
- Increase the separation between the equipment
- Connect the equipment into an outlet on a circuit different from that to which other device(s) is connected.
- Consult the field service technician or manufacturer for help

**Disposal**

Disposal of this product or parts must be carried out according to local disposal codes.

**CHAPTER TWO: SYSTEM INFORMATION**

**2.1 Utility Requirements**

**NOTE:** Prior to installing the MCB 202CD, it is necessary to provide and create an environment suitable for trouble free operation of the system.

2.1.1 Water:

RO or DI water produced to AAMI standards for Hemodialysis. A minimum of 20 PSI is recommended for consistent filling and a maximum of 60 PSI. It must not exceed 30 LPM (8 GPM).

2.1.2 Electrical:

System must be supplied with an 115V, Single Phase, 20 Amp, 60 Hz power supply. An 8 ft. cord with US type plug connector is supplied with every unit. Histories of power failure, power surges, and low line voltages should be noted and reported to the manufacturer or their agent as they may create adverse conditions for the equipment’s operation.

<b>Machine Electrical Rating Table</b>				
Part Number	Voltage Rating	Amperage Rating	Phase	HZ
200-02-251	115	7.4	1	60
200-02-252	115	9.7	1	60

2.1.3 Drain

A drain outlet is required for the Bicarb mixer. A floor drain is recommended for proper operation (minimum 1”).

2.1.4 Piping

Plumbing materials can significantly contribute to the contamination of the system. Schedule 40 or 80 PVC pipes, polypropylene, PVDF, and other FDA recommended materials are suitable for the system. Care must also be exercised in the choice of a thread sealant. Teflon tape is suitable for all threaded connections in this system.

**WARNING:** Ordinary pipe dope must be avoided since it may leach objectionable and potentially dangerous impurities into the water. For thread sealing, use a product that is compatible with pure water applications.

## **2.2 Dimensions/Operating Space**

The following are the system dimensions:

- Width: 4' 0"
- Depth: 3' 0"
- Height: 5' 1" (100 gallon) without vent filter  
3' 7" (50 gallon) without vent filter

For easy and safe operation, we recommend that there be a minimum of 2 feet on each side and 4 feet in the front of the system. Due to the wet environment, we recommend that the system be placed in a curbed area with a drain. This area should be at least 5 feet by 5 feet. The floor drain can also be used as the system drain.

**NOTE:** Do not position the unit so it is difficult to disconnect the power cord from the outlet.

### 2.2.1 Operating Weight

<u>Part Number</u>	<u>Operating Weight</u>
200-02-251	600 LBS
200-02-252	1020 LBS

## **2.3 Installation**

The bicarb system ships ready to operate. There are four system connections:

- Inlet (feed water): 3/4" schedule 80 PVC
- Drain: 1" schedule 80 PVC
- Bicarb Outlet: 3/4" GHMT
- Bicarb Return: 3/4" GHMT

**NOTE:** For the feed water line, we recommend that a valve be placed prior to the system for emergency system shut-off and that a 3 GPM flow restrictor also be installed to limit the amount of water that can be drawn off of the water system.

**NOTE:** For cleaning, we recommend a bypass around the flow restrictor to allow the unit the fill faster. This should substantially reduce the clean and disinfection time of the unit.

**NOTE:** Unions should be installed on all connections to allow the unit to be moved for servicing. Connections may be made with tubing.

## **2.4 Components of the Bicarb System**

The following identifies and describes the function of each valve and test port. All valves are tagged or labeled.

### 2.4.1 Valve Labels

- V1** - System Fill Valve
- V2** - Mix Valve
- V3** - Jug Port/Sample Valve
- V4** - System Drain Valve
- V5** - Spray Nozzle Valve
- V6** - Loop Distribution Valve
- V7** - Loop Pressure Valve
- V8** - Return Loop Valve
- Jug Port** Jug Port Valve, Pressurized Fill

**NOTE:** Valves **V7** and **V8** are diaphragm valves and are used to control the loop flow and pressure. Once these valves are set they should not require further adjustment.

### 2.4.2 Mix Tank

The tank and stand is constructed of polyethylene. It includes an eductor, which creates a swirling motion in order to properly dissolve the powder into solution. The system comes equipped with a spray nozzle, which is used to conveniently and effectively clean and disinfect the tank. The tank includes a hinge-top lid.

### 2.4.3 Pump

The system is equipped with a magnetic drive pump and motor which is designed to mix the bicarb powder into solution. It is controlled by the Pump Power Button.

### 2.4.4 Diaphragm Valves

These PVC valves are designed to control the flow and pressure of the bicarbonate loop.

### 2.4.5 Vent Filter

A vent filter is installed on the tank cover. The cartridge style vent filter inhibits dust and debris from entering the tank.



2.4.5.1 Vent Filter Installation

Remove plug from tank cover vent filter opening. Remove dist plugs from vent filter housing. Install nipple into arrow end of vent filter. Install assembled parts into tank cover.

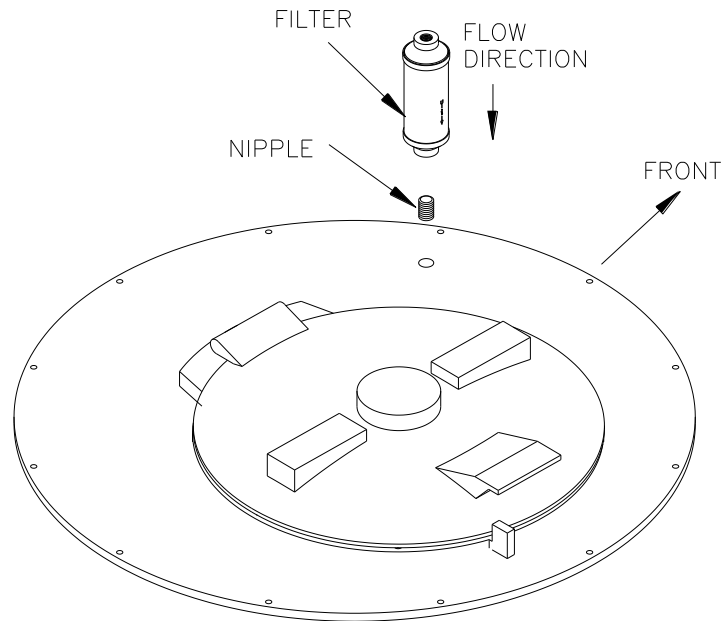

2.4.6 Pump Power Button panel selects the amount of time the pump operates, 2 minutes, 5 minutes, 10 minutes, and 15 minutes. The blank button stops the pump. To override a time selection press another time selection.

Timer Panel

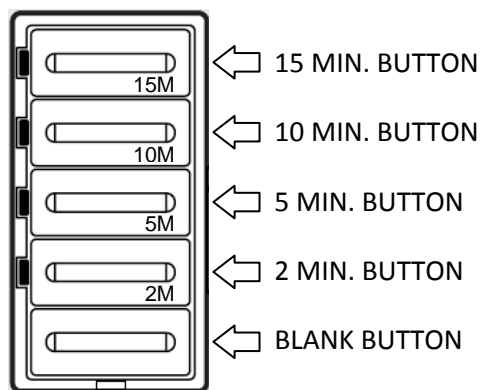

## **2.5 Service Assistance**

If service assistance is required, take the following steps:

1. Consult the “Trouble Shooting” section of this manual (Chapter 5.0). If the problem cannot be identified and corrected by any of the procedures found in that section, then . . .
2. Contact your Facility Equipment Technician. If the technician is unable to help, then . . .
3. Call Mar Cor Purification Technical Support Department at (800) 633-3080. Technicians are available for all calls between 7:00am and 7:00pm CST, Monday through Friday. Technicians are also available at other time for emergency calls only. Technicians will be on hand to discuss the problem with you and endeavor to rectify it over the phone. If the problem appears to be of a more serious nature, you will be given instructions regarding the action to be taken. Prior to making the phone call, you must be prepared to answer two questions.

1. What model do you have? \_\_\_\_\_
2. What is the serial number? \_\_\_\_\_

4. In addition, for non-Emergency issues you may email [techserv@mcpur.com](mailto:techserv@mcpur.com) and a technician will respond generally within one working day.

## **2.6 Symbols and Abbreviations**

AAMI	Association for the Advancement of Medical Instrumentation
AMP	Ampere
DI	Deionization
ft	Foot (feet)
GPM	Gallons Per Minute
GHMT	Garden Hose male Thread
hp	Horse Power
lbs	Pounds
LPM	Liters Per Minute
NPT	National Pipe Thread
PP	Polypropylene
PVC	Polyvinyl Chloride
PVDF	Polyvinylidene Fluoride
RO	Reverse Osmosis
VAC	Volts Alternating Current

## **2.7 Environmental and Storage Considerations**

- 2.7.1 Operating Temperature Range: 38 to 104°F.
- 2.7.2 Operating Relative Humidity: 45% to 85%, no condensing.
- 2.7.3 Storage Temperature Range: 38 to 104°F.
- 2.7.4 Storage Relative Humidity: 45% to 85% no condensing.

## CHAPTER THREE: INITIAL SYSTEM START-UP

### **3.1 Bicarb System Set-Up**

<p><b>WARNING:</b> The Bicarb System and Bicarb Distribution Loop needs to be cleaned and disinfected prior to being ready for patient use.</p>
-------------------------------------------------------------------------------------------------------------------------------------------------

1. Place Bicarb System into position and attach AAMI quality feed water to the inlet and then make the necessary drain connections.
2. All valves should be in the closed position.
3. Plug the system in per specifications (Refer to Section 2.1).
4. The system should be cleaned and disinfected prior to initial use. Follow System Clean/Disinfect steps under Section 5.0.
5. Once the system has been cleaned and disinfected. Proceed to Section 4.0 for System Operation.

**CHAPTER FOUR: SYSTEM OPERATION****4.1 Bicarb Mixing**



**WARNING:** If the Cleaning/Disinfecting procedure was used prior to a new batch of bicarb being made, a residual test should be performed prior to the initiation of the mixing cycle (see the rinse procedure in Section 4.2 if necessary).

1. Open **V1** and fill tank to 95 liters (25 Gallons). Close **V1**.
2. Open **V2** and ensure **V5** is closed.
3. Turn pump ON for 10 minutes by pressing  button.
4. Adjust mix flow using mix control valve **V2** to minimize vortex if necessary.
5. Slowly add bicarb powder through hinged lid.

**CAUTION:** If bicarb powder is added too fast, the pump may clog and could result in irreversible damage to the pump.

6. If necessary, open **V1** and fill the tank to the desired batch level.
7. Close **V1** and continue mixing until powder is dissolved.

**NOTE:** Total mixing time should not exceed 10 minutes.



8. Pump should turn OFF automatically. Press the  button to stop pump.
9. Close **V2**.
10. Pull sample for testing from **V3**. Upon approval, proceed.
11. Fill jugs manually at Jug Access Port **V3**.
12. To fill jugs using the pump, open **V2**. Place an empty jug under the **Jug Port** valve. Press the  button and use the **Jug Port** valve to fill the jugs.

**CAUTION:** Operating the Jug Port valve while the mixer is in the ON mode must be done with care. Contents are under pressure causing the jugs to fill quickly. Do not leave unattended.

13. Once filling is complete, press the  button to stop the pump. Close the **Jug Port** valve and **V2**.

**CAUTION:** To use the mixed bicarbonate solution in the tank follow Step 12. Do not run the pump dry or irreversible damage could occur.

**4.2 Bicarb Distribution**

1. Ensure all valves (except **V7** and **V8**) are closed.
2. Open **V6**.
3. Turn the pump ON using  button, lift finger off the  button for 2 seconds then press  button again, the pump will now stay ON for 24 hours.
4. Balance the loop flow and pressure with the two diaphragm valves (**V7** and **V8**). Reference the pressure with the pressure gauge.

**NOTE:** This should only have to be done one time. These valves should not be manipulated during normal system operation.

5. To discontinue distribution, switch the pump OFF by pressing the  button and close valve **V6**.

## CHAPTER FIVE: SYSTEM CLEANING AND DISINFECTING

### 5.1 Introduction



**NOTE:** Disinfecting should be done every night after system operation unless proven documented results in accordance with customer's policies and procedures demonstrate otherwise so as to maintain bacteria and endotoxin levels that are in accordance with AAMI standards. It is recommended that the system be disinfected on a weekly basis.



For disinfecting, the recommended total contact time for the bicarb system is one (1) hour. This includes introducing the approved disinfecting agents (1% peracetic acid or household bleach 1% mixture by volume), recirculating the solution through the system, testing for positive presence at each point, dwell time, and rinsing. If less time (for example 30-45 minutes) is practiced and still maintains acceptable culture results than that can be used as an approved maintenance practice. However, if higher culture counts are noted than a change in the practice is required. Mar Cor Purification recommends that the system be rinsed every night following normal system operation.

1. There are 3 basic steps to disinfecting the bicarb system:
  - a. STEP 1: System Pre-Rinse (Section 5.2) – designed to rinse bicarb from the system. This procedure should be done nightly after normal operation.
  - b. STEP 2: System Disinfecting (Section 5.3) – procedures for cleaning/disinfecting the bicarb system.
  - c. STEP 3: System Rinsing (Section 5.4) – procedures for rinsing out the cleaning/disinfecting solution in order to return the system to normal operation.



**WARNING:** System disinfecting should NOT be done while the bicarb system is in use for patients or possible harm could occur.

### 5.2 Bicarb System Pre-Rinse

1. After completion of jug filling (either method), drain any solution using valve **V4**.
2. Close valves **V2, V3, V4, V5, V6, and Jug Port**.
3. Using valve **V1**, add 95 liters (25 gallons) of AAMI quality water, close valve **V1** when completed.
4. Open valve **V6**. Valve **V7** and **V8** should already be open to circulate water in the pump.
5. Press the  button to rinse the loop.
6. After the pump shuts off, drain all the solution from the tank using valve **V4**, close valve **V4** when the tank is completely drained. If the pump keeps running after the 5 minutes ends press the  button to stop the pump.
7. Repeat Steps 3-6 until all residual bicarbonate is absent from the distribution loop.

8. Close valve **V6** and open valve **V2**.
9. Using valve **V1**, add 95 liters (25 gallons) of AAMI quality water, close **V1** when done.
10. Press the  button to rinse the pump. During this 2 minute cycle, place a container under the **Jug Port** valve or run to drain. Open the **Jug Port** valve and rinse for 30 seconds then close the **Jug Port** valve.
11. Once the pump shuts off, close valve **V2** and open valve **V5**. If the pump keeps running after the 2 minutes ends press the  button to stop the pump.

**CAUTION:** Make sure the tank lid is closed on the top of the tank or the operator might be sprayed.

12. Press the  button to rinse the tank. During this 5 minute cycle, place a container under valve **V3** or run to drain. Open the valve **V3** and rinse for 30 seconds then close the valve. If the pump keeps running after the 5 minute ends press the  button to stop the pump.
13. Repeat Steps 9-12 until all residual bicarbonate is absent from the bicarb system. Once clear, open valve **V4** to drain the tank, closing it when the tank is completely drained.
14. The bicarb system and loop has now been successfully rinsed.

### **5.3 Bicarb System Disinfecting**

1. Determine the disinfecting batch size that is required up to the tank's maximum level. **Batch Size** is based on the following parameters:
  - a. The disinfecting agent solution strength. See Section 6.0 for specifications on cleaning/disinfecting agents.
  - b. Enough water for the tank and piping. Minimum recommended is **95 liters (25 gallons)**.
2. Drain the liquid left in the tank by opening valve **V4**. After the tank is completely drained then close valves **V2, V3, V4, V5, V6**, and **Jug Port**.
3. Using valve **V1**, add the necessary amount of AAMI quality water, close **V1** when completed.
4. Open valve **V2** and verify that **V6** is closed.
5. Press the  button to circulate the water to begin disinfecting the pump.
6. Add the disinfectant solution slowly through the top of the bicarb mix tank.





**WARNING:** Wear gloves, eye protection, and all PPE as required.

**WARNING:** Place a label or sign on the Bicarb system stating "WARNING DO NOT USE".

7. Test the solution per the manufacturer's recommendation through valve **V3** allowing it to run for 30 seconds into a container, and then close valve **V3**.

8. Place a container under the **Jug Port** valve or run to drain. Open the **Jug Port** valve and flush for 30 seconds, and then close the **Jug Port** valve.
9. After the pump shuts off, open valve **V5** and close valve **V2**. If the pump keeps running after the 2 minutes ends press the  button to stop the pump.

**CAUTION:** Make sure the lid is closed on the top of the tank or the operator might be sprayed.



10. Press the  button to begin disinfecting the tank.
11. After the pump shuts off, open valve **V6** and close valve **V5**. Verify valve **V7** and valve **V8** are open. If the pump keeps running after the 5 minutes ends press the  button to stop the pump.
12. Press the  button to begin disinfecting the loop. During the 5 minute cycle, test for the presence of disinfectant at all points of use. If more time is required, press the  button again.

**NOTE:** Allow the entire system to dwell for 1 hour. Recirculate every 15 minutes for 5 minutes. When disinfecting, the recommended total contact time is 1 hour. Contact time begins at the time the disinfectant solution was introduced into the system.



13. After the necessary contact time has expired, close valve **V6**, then drain all of the solution from the tank using valve **V4**, closing it when the tank is completely drained.
14. To rinse the system, follow the steps in Section 5.4.

#### **5.4 Bicarb System Rinse**



**WARNING:** Keep all warning labels or signs in place until final rinse steps are completed. Use the appropriate residual test to verify absence of cleaner/disinfectant. Wear all necessary PPE.

1. Drain the liquid left in the tank by opening valve **V4** after the tank is completely drained close valves **V2**, **V3**, **V4**, **V5**, and the **Jug Port** valve. Using valve **V1**, add 95 liters (25 gallons) of AAMI quality water, close valve **V1** when completed.
2. Open valve **V6**. Valve **V7** and valve **V8** should already be open to circulate water in the loop.
3. Press the  button to rinse the loop.
4. After the pump shuts off, drain all of the solution from the tank using valve **V4**, close when the tank is completely drained. If the pump keeps running after the 5 minutes ends press the  button to stop the pump.
5. Repeat Steps 1-4 until residual cleaner/disinfectant is absent from the distribution loop.
6. Close valve **V6** and open valve **V2**.



7. Using valve **V1**, add 95 liters (25 gallons) of AAMI quality water, close valve **V1** when completed.
8. Press the  button to rinse the pump. During this 2 minute, place a container under the **Jug Port** valve or run to drain. Open the **Jug Port** valve and rinse for 30 seconds then close the **Jug Port** valve.
9. Once the pump shuts off, close valve **V2** and open valve **V5**. If the pump keeps running after the 2 minutes ends press the  button to stop the pump.

**CAUTION:** Make sure the tank lid is closed on the top of the tank or the operator might be sprayed.

10. Press the  button to rinse the tank. During this 5 minute cycle, place a container under valve **V3** or run to drain. Open the valve **V3**, rinse for 30 seconds then close valve **V3**. If the pump keeps running after the 5 minutes ends press the  button to stop the pump.
11. Repeat Steps 7-10 until all cleaner/disinfectant is absent from the bicarb system. Once cleaner/disinfectant is absent, open valve **V4** to drain the tank, closing the valve **V4** when the tank is completely drained.
12. If the tests are positive for cleaner/disinfectant, repeat Steps 1-11 until **V3, Jug Port** valve, and all other points of use on the bicarb system and loop test negative for the presence of cleaner/disinfectant solutions.
13. Record date, time, and the operator's initials on a log sheet.
14. The system is now cleaned/disinfected and thoroughly rinsed. Remove all warning labels or signs. The system is now ready for normal operation.

**WARNING:** Due to the possibility of disinfectant rebound, a residual test should be performed prior to the initiation of the mixing cycle for bicarbonate.

---

**CHAPTER SIX: SYSTEM MAINTENANCE****6.1 Bicarb Components**

- 1 Pump - The pump is a 3/4 hp (100 gallon) or 1/2 hp (50 gallon) TEFC motor that requires no maintenance.

**CAUTION:** The mix pump must be kept clean to assure long life with minimal interruptions. We recommend the use of vinegar in the pump on a quarterly basis to keep bicarb from calcifying in the pump head.

- 2 Inspect the unit's hoses, fittings and PVC pipes every week for leaks or damage. Replace as needed. The spare part numbers for the hoses and fittings can be found in Section 8 of this manual. Contact Mar Cor's Technical Service Department for assistance.
- 3 System Disinfecting – Disinfection should be done with agents that meet the following criteria:
  - a. Peracetic Acid – Per manufacture's specifications (1% Minncare is standard and recommended).
  - b. Bleach, Household – 1% mixture (By Volume).
4. Check the bicarb vent filter monthly for the presence of moisture. Remove the filter and shake it with a downward motion, causing any water to be expelled. Replace the vent filter if any water is expelled.
5. Check the bicarb tank manway lid monthly for cracks or degradation. Replace if necessary.

Chemical Mix Table						
Disinfectant	QTY	%		Decalcifier	QTY	%
Bleach (Household)	0.95 Liters or 32 ounces	1%		Acetic Acid	4.73 Liters or 1.25 Gallons	5%
Peracetic Acid (Minnicare)	0.95 Liters or 32 ounces	1%		Citric Acid	4.73 Liters or 1.25 Gallons	5%
<p><b>NOTE:</b> Add quantities listed to 95 liters (25 gallons) of water.</p> <p><b>WARNING:</b> Do Not Mix Chemical Together.</p> <p><b>WARNING:</b> Follow all applicable Material Safety Data Sheet (MSDS) precautions and OSHA Standards when handling any chemical. Use the appropriate Personal Protective Equipment when handling any chemical. Follow all local, state, and federal regulations when disposing of any chemical.</p>						

**6.2 Schedule**

1. Daily Maintenance. The Bicarb System should be cleaned every evening after the final patient shift. See Section 5.1.
2. Weekly Maintenance. The Bicarb system should be rinsed and disinfected after the final patient shift. See Section 5.1. The unit must then be rinsed of the disinfectant and have a negative result. Inspect the system for leaks or damage Repair as necessary.
3. Monthly Maintenance. Bacterial monitoring should be preformed on a monthly basis once the initial cultures have been preformed on the system. After disinfection and rinse, the bacteria samples should be retaken and tested accordingly. Follow clinics procedures as required.
4. Quarterly Maintenance. The Bicarb System should be decalcified. Acetic acid (e.g. vinegar) or citric acid is an acceptable solution. This may need to be performed more often depending upon precipitation formation.
5. Yearly Maintenance. Replace the vent filter.

**CHAPTER SEVEN: TROUBLESHOOTING****7.1 Mix/Distribution Pump**

1. Pump Noisy
  - a. Verify fluid availability.
  - b. Ensure proper ball valve orientation. Pump will not function properly without fluid.
  - c. Clean the pump to remove any bicarbonate build-up.
  - d. Inspect the pump for damage.
  - e. Replace the pump.
2. Pump Does Not Run
  - a. Verify fluid availability.
  - b. Make sure the unit is plugged in and with power to the outlet.
  - c. Faulty motor, replace the pump.
3. Pump Continues Running
  - a. Depress the  button.
  - b. Check the Pump Power Button.
  - c. Unplug the MCB202 from the electrical power source.

**7.2 Tank Fill**

1. No Water
  - a. Check to make sure purified water is turned on or opened to the unit.
  - b. Replace the valve.

**7.3 System Flow**

1. System Distribution Does Not Occur
  - a. Verify proper valve orientation.
  - b. Refer to Section 7.1.
2. No Bicarb Flow From Jug Fill/Sample Valve
  - a. The **V3** jug fill works with gravity pressure. There needs to be a minimum of 38 liters (10 gallons) in the tank.
  - b. Use the **Jug Port** valve to fill a jug using pump pressure. Be sure **V2** is OPEN and the pump is operating.

**CHAPTER EIGHT: SPARE PARTS & SUPPLIES**

Supplies and replacement parts are available from Mar Cor Purification by calling 1-800-752-1402. Replacement parts can be ordered by referring to the system diagram. The following supplies are available and can be shipped immediately:

**Spare Parts List:**

Description	Part Number
Minnicare 400 Cold Sterilant, 4 x 1 quart, case	176-01-001
Minnicare 1% test strips	185-40-005
Minnicare residual test strips	185-40-004
¾ hp Mix pump (100 gallon)	028-07-001
½ hp Mix pump (50 gallon)	028-06-002
Pump Wet End Kit (100 gallon)	028-83-176
Pump Wet End Kit (50 gallon)	028-83-174
¾" Compact Ball Valve, PVC	425-04-103
1" Compact Ball Valve, PVC	425-04-104
¾" T/U Ball Valve, PVC	425-01-162
¾" MNPT x 3/4" MGHT Dixon	350-11-004
¾" MNPT x 1/2" HB 90 Dixon	350-15-012
Flow control nipple, PVC, 3 gpm	425-27-239
Filter,5 micron, tank cover	ME41383
O-ring,16" DIA, EPDM	1236603

**CHAPTER NINE: DRAWINGS**

**MCB202 CD - Bicarb Mix Tank With Central Distribution**

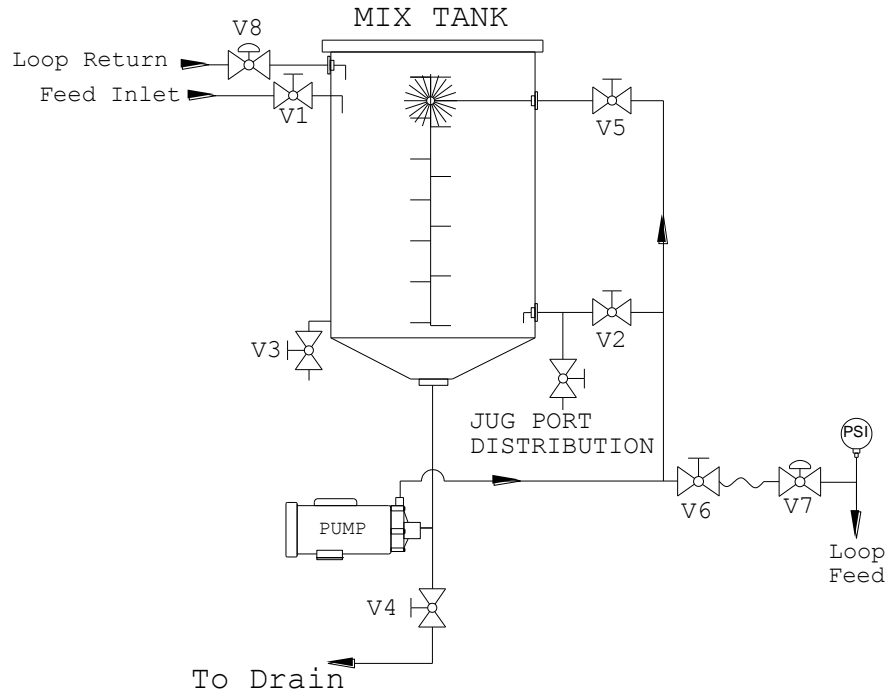

**Fill Mode**

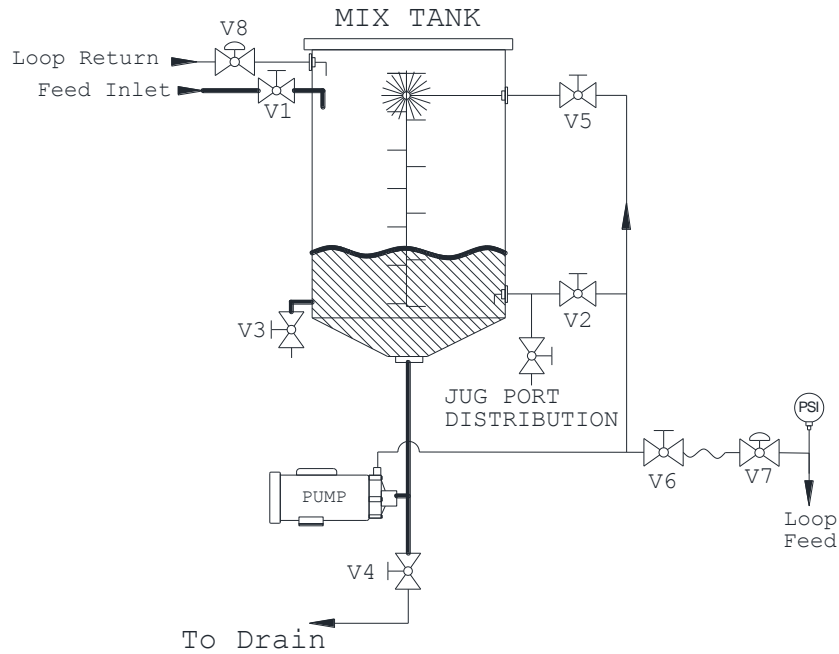

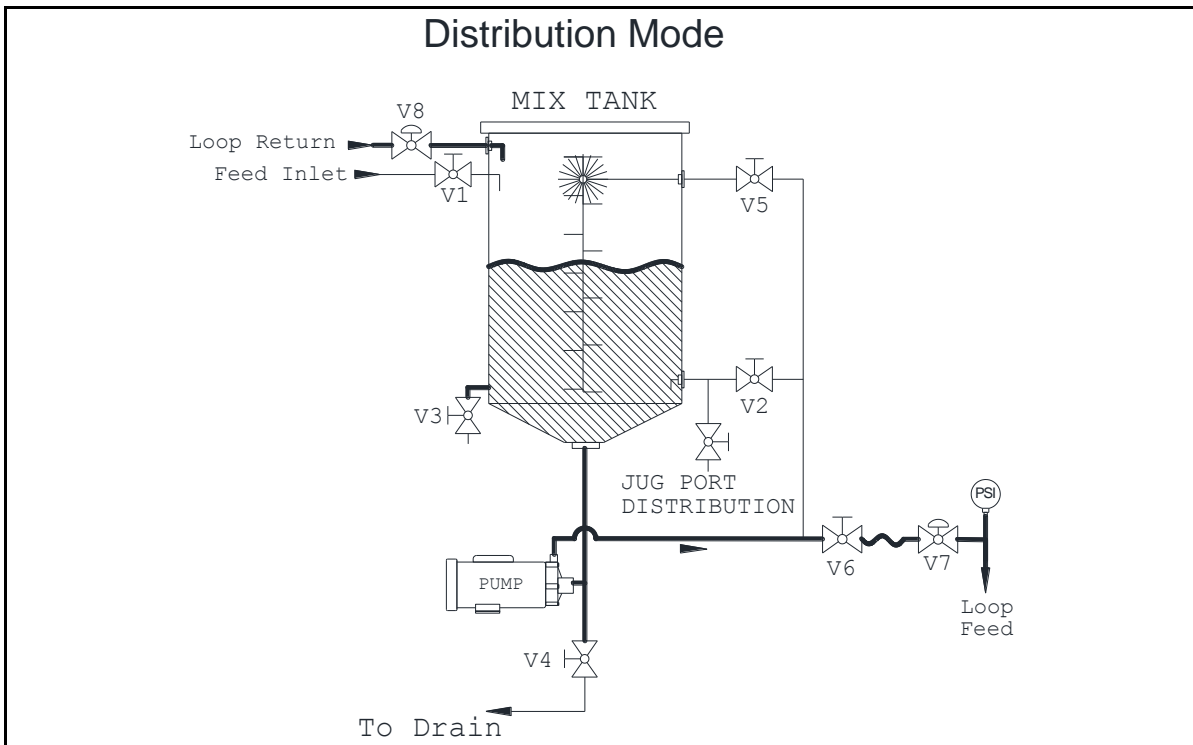
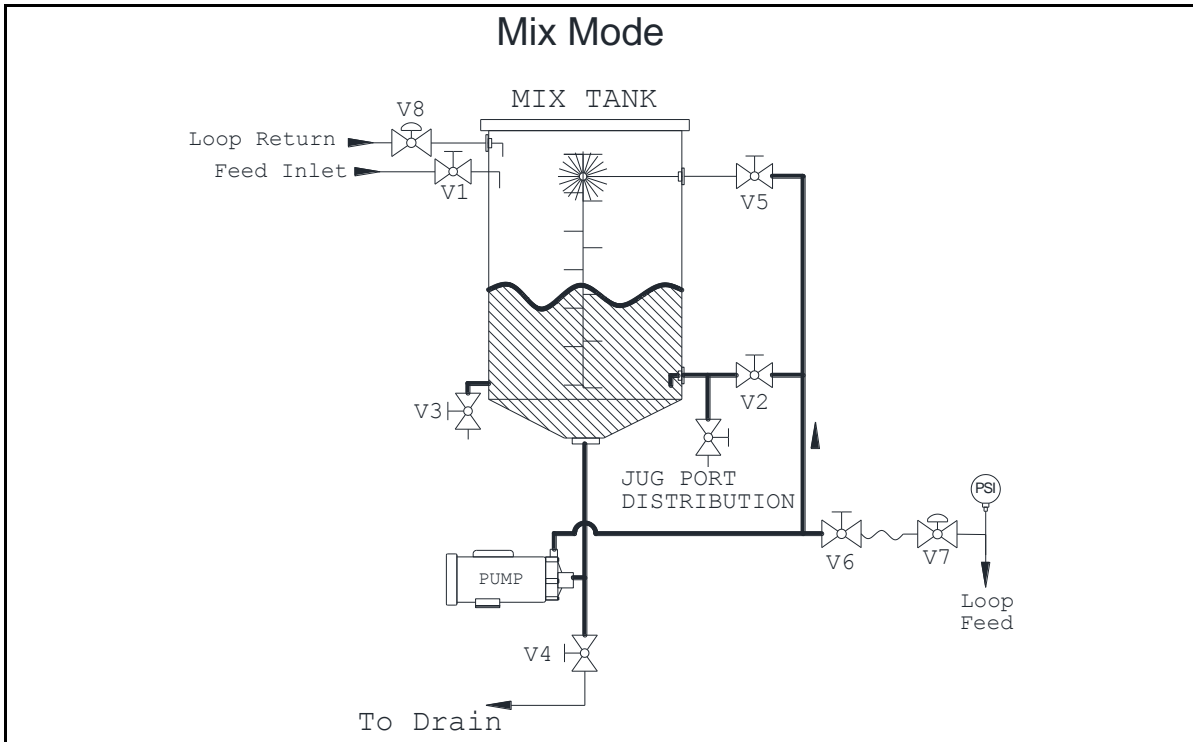

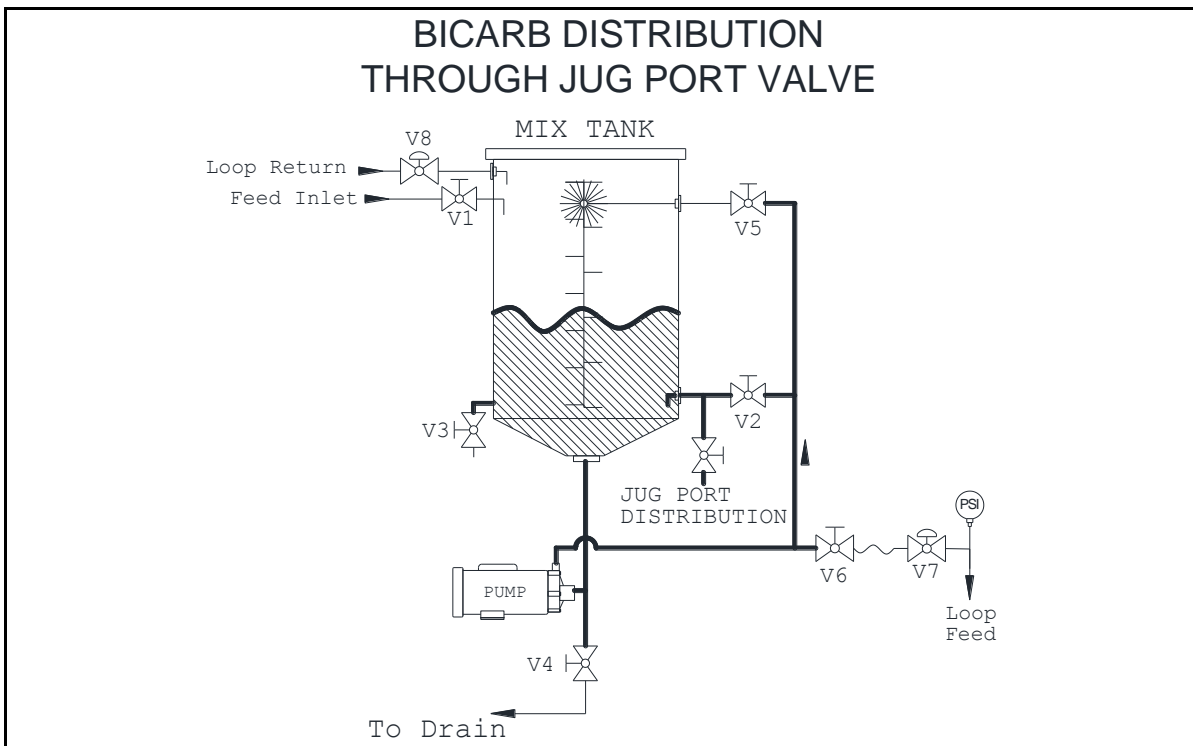
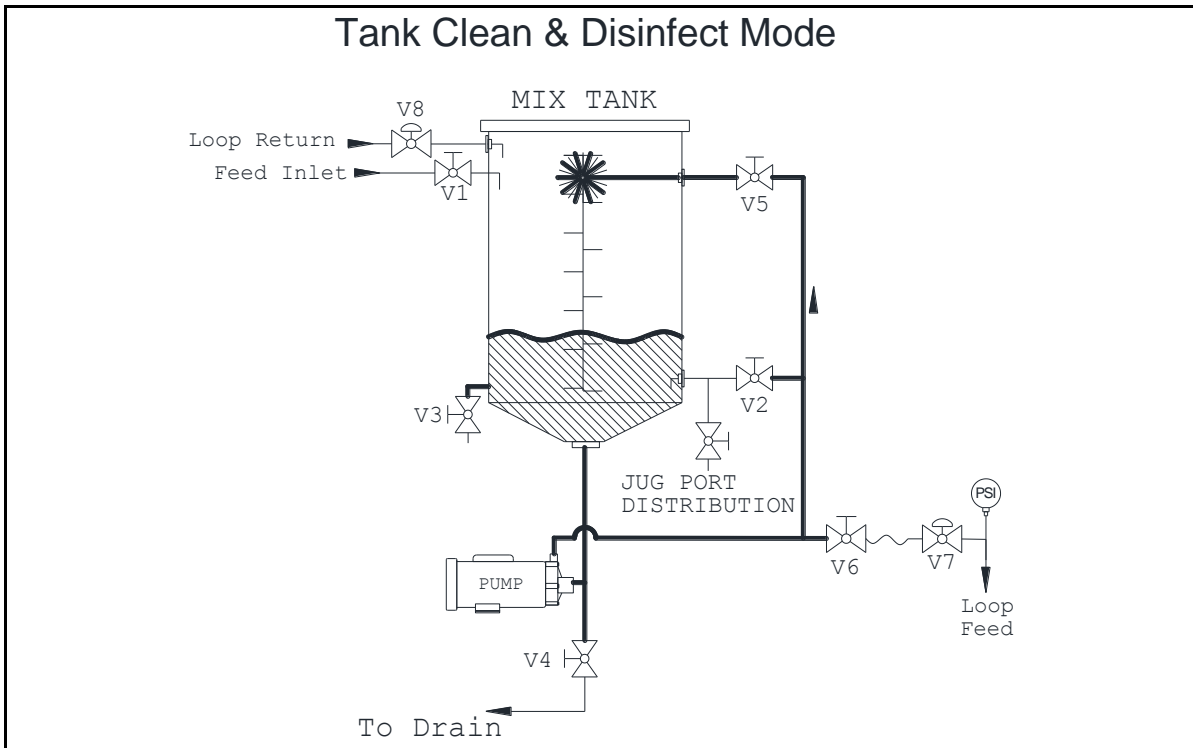







Call **(800) 633-3080** for additional information or visit **[www.mcpur.com](http://www.mcpur.com)**.

---



14550 28<sup>th</sup> Ave N,  
Plymouth, MN 55447  
Ph: 800-633-3080  
Fax: 763-210-3868